

PLANTA BAIXA-TANQUE SÉPTICO

CORTE DD

Esc.: 1:50

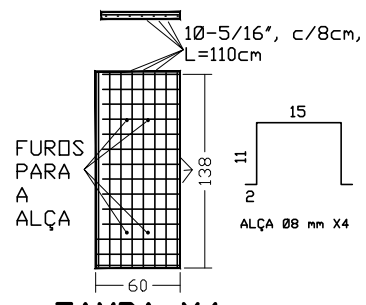

TAMPA X4

60x140 x 4
Esc.: 1 / 50

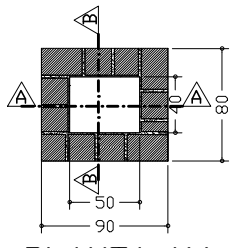

PLANTA X4

Esc.: 1:50

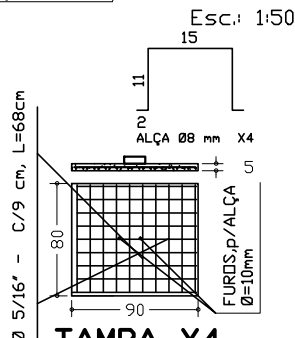

TAMPA X4

Esc.: 1:50

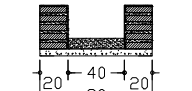

CORTE AA

Esc.: 1:50

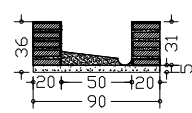

CORTE BB

Esc.: 1:50

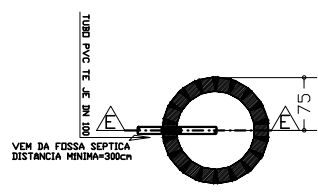

PLANTA BAIXA SUMIDOURO

Esc.: 1 / 100

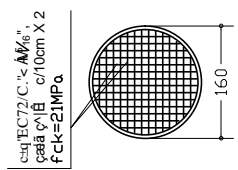

TAMPA, SUMIDOURO

Esc.: 1 / 100

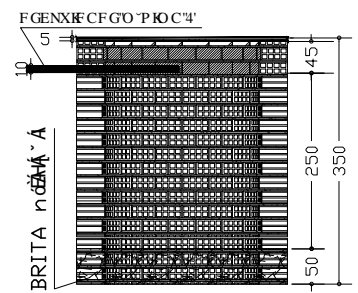

CORTE EE SUMIDOURO

Esc.: 1:100

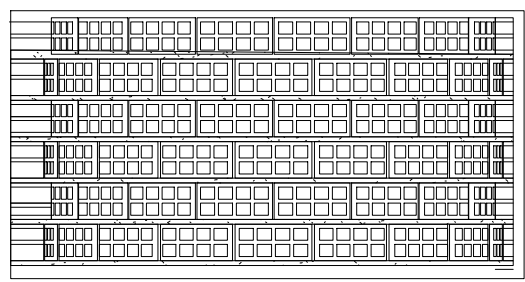

DETALHE: ALVENARIA SUMIDOURO

Esc.: 1:50

Projeto de **H I D R O S A N I T Á R I O**

ASSINATURAS

AUTOR DO PROJETO
Engo Civil :

Nome e CREA

Á R E A S (m ²)			
TERRENO	CONSTRUÍDA	LIVRE	TOTAL
VARIÁVEL	44.982	VARIÁVEL	44.982

ASSUNTOS: **planta baixa/cortes, cx passagem, tanque séptico e sumidouro**

ESCALAS : INDICADAS (cotas em cm) PRANCHA: 7/9 DBRA: RESIDENCIAL UNI-FAMILIAR

DATA: Julho/2013

APROVAÇÃO: